



STIL
NOVO

GAS SYSTEM

outdoors

2016

MADE IN ITALKERO

gas system

l'emozione della fiamma avvolgente, tecnologia innovativa Italkero!

the emotion of an enchanting flame, innovative Italkero technology!

"GAS SYSTEM", un'idea esclusiva Italkero, è l'innovazione tecnologica a gas nel mondo dei camini che offre risultati eccellenti.

Puoi godere la bellezza della fiamma accendendo il focolare con un telecomando.

L'opzione della legna "particolare" ti permetterà di avere lo stesso effetto di un camino tradizionale ma con un grande vantaggio: **NON DOVRAI MAI CAMBIARLA!**

"Gas system" is an exclusive Italkero idea, it's a technological innovation for the gas fireplace world that offers excellent results.

You can enjoy the beauty of the flame simply by turning on the fire with a remote control.

*Our unique ceramic wood assures the same effect of a traditional fireplace with an incredible advantage to you: **YOU WON'T EVER NEED TO CHANGE THE WOOD!!***



dolce vita



04

dolce vita e.p.

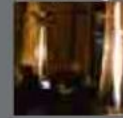

06

falò evo



08

falò



12

torcia



14

spider

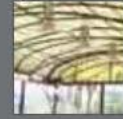

16

technical data



18

accessories



19

dimension



22

dolce vita

riscaldatori decorativi da esterno
decorative outdoor heaters



Dolce Vita con luci
Dolce Vita with lights

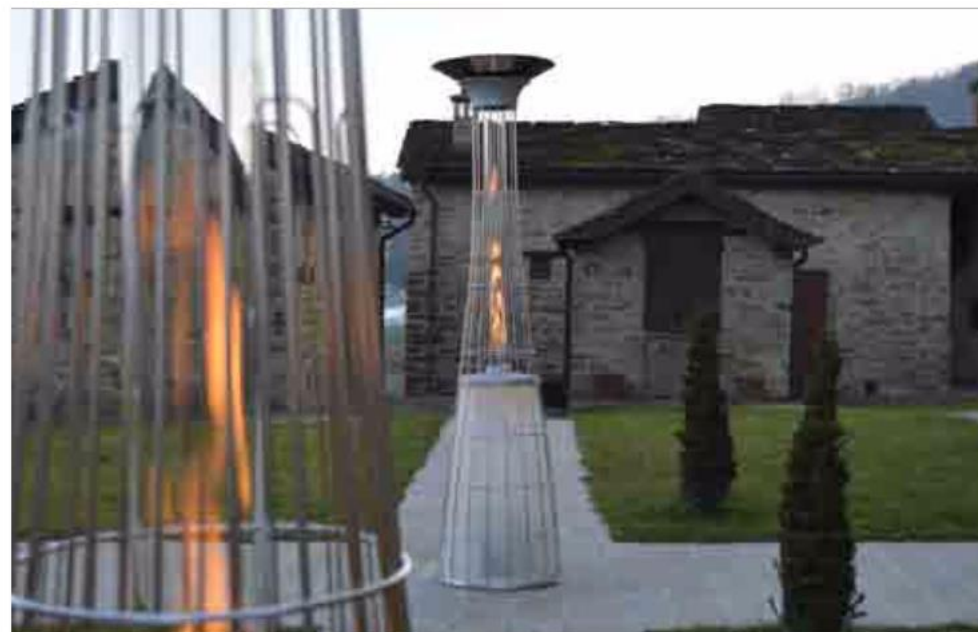

Dolce Vita senza luci
Dolce Vita without lights

Dolce Vita con luci
Dolce Vita with lights



dolce vita E.P. energy producing

riscaldatori decorativi da esterno
decorative outdoor heaters

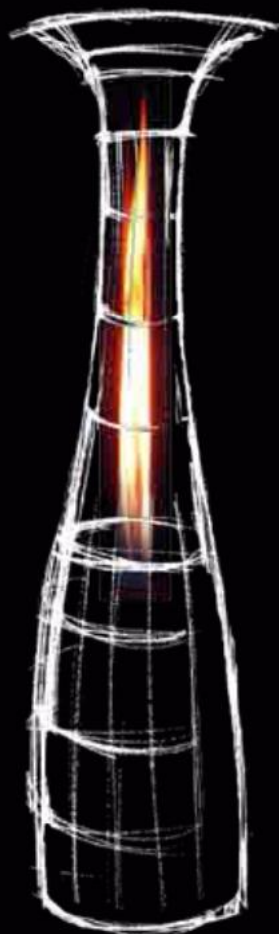

Dolce Vita E.P.
(electricity producing)



Dolce Vita E.P.
(electricity producing)



Dolce Vita E.P.
(electricity producing)





Tralkero

Falò evo black, riscaldatore da esterno
Falò evo black, *luxury patio heater*



falò evo

riscaldatori decorativi da esterno
decorative outdoor heaters



Falò evo



Falò evo
black



Falò evo
ruggine/rust

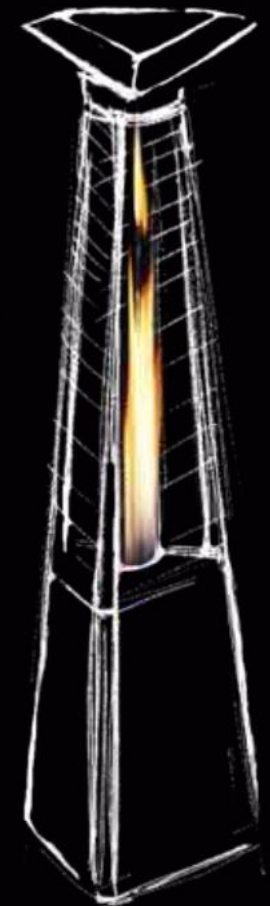



Falò evo ruggine, riscaldatore da esterno
Falò evo rust, luxury patio heater



falò evo

riscaldatori decorativi da esterno
decorative outdoor heaters



Falò evo
color

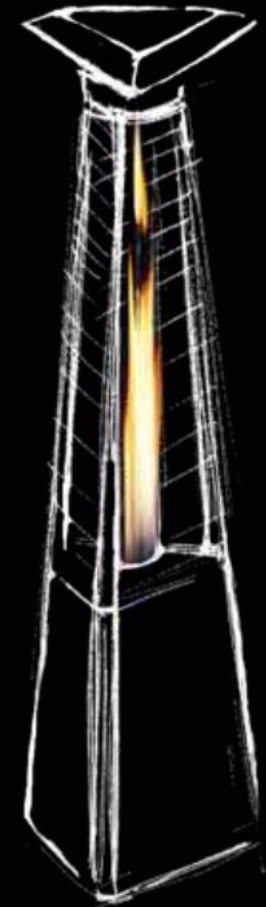
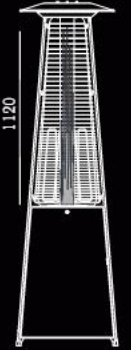



Falò, riscaldatore da esterno
Falò, luxury patio heater



Falò, riscaldatore da esterno
Falò, *luxury patio heater*



falò

riscaldatori decorativi da esterno
decorative outdoor heaters



Falò, riscaldatore da esterno
Falò, *luxury patio heater*

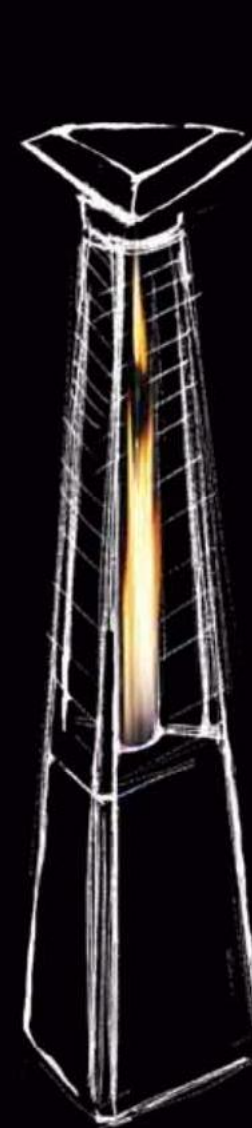

torcia

braciere, installazione esterna
gas fire pits, outdoor installation

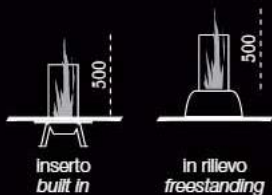

braciere in rilievo
freestanding gas fire pits

braciere in rilievo
con kit luci led
*freestanding gas fire pits,
with led lights kit*





*braciere ad incasso,
built-in gas fire pits*



appeso, con telecomando
ceiling, with remote control



appeso, con telecomando
ceiling, with remote control



appeso, con telecomando
ceiling, with remote control



Spider

riscaldatori appesi da esterno
ceiling outdoor heaters





modello model	Dolce Vita comando manuale manual control	Dolce Vita comando infrarossi remote control	Dolce Vita E.P. (electricity producing) comando infrarossi remote control	Falò EVO comando manuale manual control	Falò EVO comando infrarossi remote control	Falò comando manuale manual control	Falò comando infrarossi remote control
codice GPL code LPG	LF12M2 L0000	LF12A2 L0000	LF12A2 LG000	FL12ME L0100 FL12ME L0200 - 300 - 400	FL12AE L0100 FL12AE L0200 - 300 - 400	FL12M0 L0100	FL12A0 L0100
codice Metano code Methane	LF12M2 M0000	LF12A2 M0000	LF12A2 MG000	FL12ME M0100 FL12ME M0200 - 300 - 400	FL12AE M0100 FL12AE M0200 - 300 - 400	FL12M0 M0100	FL12A0 M0100
struttura structure	INOX brillantato stainless STEEL	INOX brillantato stainless STEEL	INOX brillantato stainless STEEL	ALLUMINIO + verniciatura ALUMINUM + trasparente painted	ALLUMINIO + verniciatura ALUMINUM + trasparente painted	ALLUMINIO + verniciatura ALUMINUM + trasparente painted	ALLUMINIO + verniciatura ALUMINUM + trasparente painted
vista fiamma h (cm) flame view h	110	110	110	112	112	141	141
portata (kW) heat input	12	12	12	10,2	10,2	12	12
alimentazione (V) power supply	nr. 1 x 1,5 (tipo AA)	nr. 2 x 1,5 (tipo torcia D)	nr. 2 x 1,5 (tipo torcia D)	nr. 1 x 1,5 (tipo AA)	nr. 2 x 1,5 (tipo torcia D)	nr. 1 x 1,5 (tipo AA)	nr. 2 x 1,5 (tipo torcia D)
alimentazione luci LED (V) LED lights power supply	12	12					
peso netto (Kg) net weight	27	28	31	28	29	29	30
peso lordo (Kg) gross weight	40,5	41,5	44,5	40,5	41	41,5	42



modello model	Torcia 90 (in rilievo / freestanding) comando infrarossi remote control	Torcia 90 (inserto / built in) comando infrarossi remote control	Spider (appeso / ceiling) comando infrarossi remote control
codice GPL code LPG	TN90A0 L0000	TN90A0 L1000	RE07AS L0000
codice Metano code Methane	TN90A0 M0000	TN90A0 M1000	RE07AS M0000
copertura cover	ALLUMINIO + verniciatura ALUMINUM + trasparente painted		
vista fiamma h (cm) flame view h	50	50	
portata (kW) heat input	3	3	7,5
alimentazione (V) power supply	nr. 2 x 1,5 (tipo torcia D)	nr. 2 x 1,5 (tipo torcia D)	nr. 2 x 1,5 (tipo torcia D)
alimentazione luci LED (V) LED lights power supply	12		
peso netto (Kg) net weight	7	8	9
peso lordo (Kg) gross weight	8	9	10,3

Accessori • Accessories *DolceVita, DolceVita E.P., Falò EVO, Falò, Spider, Torcia*



Telecomando.

Remote control.

code model
70001552 00 DolceVita, Falò, Falò evo, Spider.



KIT luci LED SENSOR (attivazione a sfioramento del sensore): luci LED, batteria, kit di ricarica, supporto batteria.

NOTA: non installabile su modello E.P.

Sensor LED lighting kit: led lights, rechargeable battery, recharge kit and battery support.

NOTE: not for E.P. model.

code model
70001561 00 DolceVita, Torcia.



Tavolino Caffè, diametro 80cm (stratificato per utilizzo da esterno, laminato bianco).

Coffee table, external diameter Ø 80cm (stratified for outdoor use, white laminated).

code model
70001571 00 DolceVita.

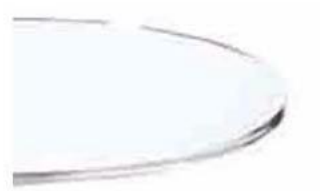

Tavolino Caffè (plexiglass trasparente), diametro esterno 80 cm.

Coffee table (transparent plexiglass), outside diameter 80 cm.

code model
70001572 00 DolceVita.



Batteria addizionale.

NOTA: installabile anche su modello E.P.

Additional rechargeable battery.

NOTE: it can be installed on E.P. model.

code model
70001562 00 DolceVita.

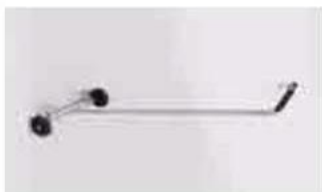

Trolley addizionale per il trasporto.

Additional trolley.

code model
70004566 00 DolceVita.



Cappello grande (diametro esterno Ø75cm).

Larger hat (external diameter Ø 75cm).

code model
70001581 00 DolceVita.



Ruote per trasporto.

Wheels.

code model
70004565 00 Falò, Falò evo.



Tavolino Caffè (stratificato per utilizzo da esterno, laminato bianco).

Coffee table (stratified for outdoor use, white laminated).

code model
70001575 00 Falò evo.



Tavolino Caffè (plexiglass trasparente).

Coffee table (transparent plexiglass).

code model
70001576 00 Falò evo.



Kit alimentazione elettrica (3V-35mA), per non sostituire le pile nell'unità ricevente.

Power supply kit (3V - 35mA).

code model
70004540 00 Spider.

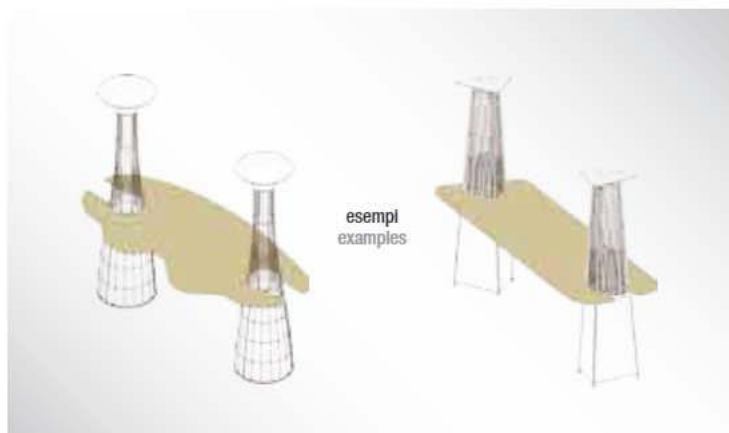

esempi
examples

Piano d'appoggio su misura.

NOTA: contattare l'Uff. Commerciale per definire

- forma desiderata
- dimensione
- tipo di materiale (vetro, legno, ecc.)
- costo e tempi di consegna.

Support plane.

NOTE: contact the Sales office to define

- desired shape
- size
- type of material (glass, wood, etc.)
- cost and delivery times.

code model
000015 DolceVita.
000016 Falò evo.

tavolino e piani d'appoggio • table and tops

DolceVita, DolceVita E.P.

tavolino caffè
coffee table

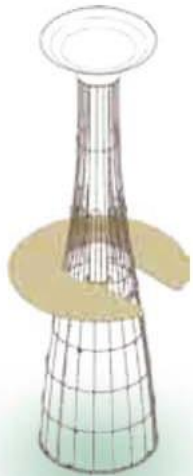
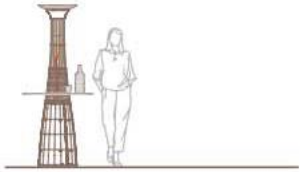

piano d'appoggio tra due apparecchi
table top between two devices

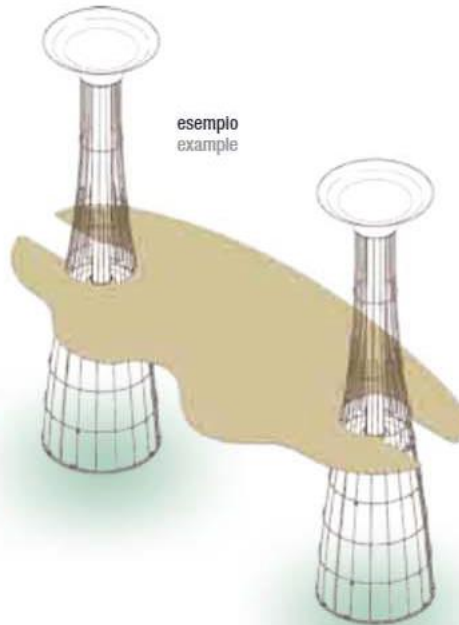
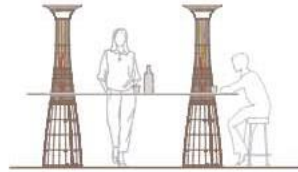

piano d'appoggio tra apparecchio e piede di sostegno (realizzato dall'utente)
table top between the device and foot support (created by the user)

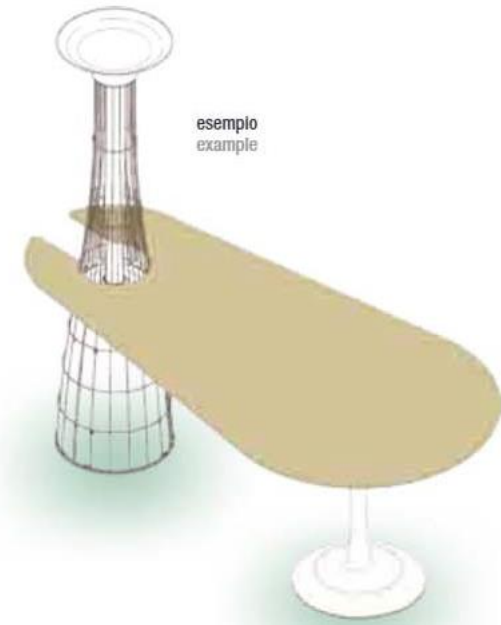
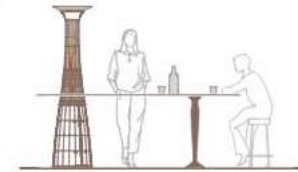

Falò EVO, Falò

tavolino caffè
coffee table



piano d'appoggio tra due apparecchi
table top between two devices

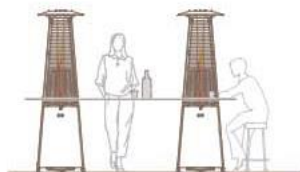

piano d'appoggio tra apparecchio e piede di sostegno (realizzato dall'utente)
table top between the device and foot support (created by the user)

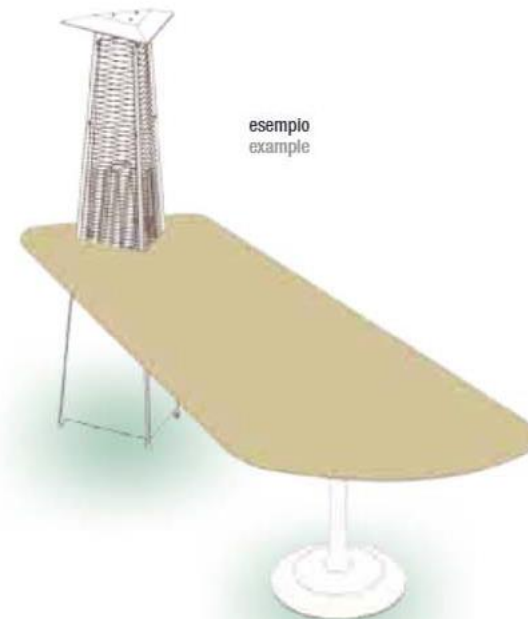
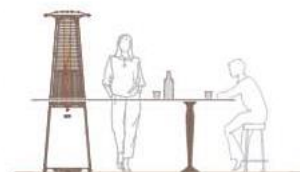

dimensioni • dimensions

DolceVita comando MANUALE DolceVita MANUAL control



Dotazioni:

- trolley per il trasporto
- dispositivo di sicurezza antiribaltamento con blocco automatico alimentazione gas
- struttura in acciaio INOX brillantato
- comando manuale, vari livelli di potenza

Equipped:

- trolley
- anti-tipping device
- polished stainless steel structure
- manual control, various power levels

DolceVita comando INFRAROSSI DolceVita REMOTE control



Dotazioni:

- trolley per il trasporto
- dispositivo di sicurezza antiribaltamento con blocco automatico alimentazione gas
- struttura in acciaio INOX brillantato
- centralina comando con ricevitore, 3 livelli di potenza

Equipped:

- trolley
- anti-tipping device
- polished stainless steel structure
- remote control, 3 power levels

DolceVita E.P. comando INFRAROSSI (electricity producing) E.P. DolceVita with REMOTE control (electricity producing)



electricity producing



l'accessorio batteria consente l'accensione delle luci con l'apparecchio non funzionante

this accessory battery lets you turn on the lights with the unit is not in operation

Dotazioni:

- trolley per il trasporto
- dispositivo di sicurezza antiribaltamento con blocco automatico alimentazione gas
- struttura in acciaio INOX brillantato
- centralina comando con ricevitore, 3 livelli di potenza
- luci LED SENSOR (attivazione con sfioramento del sensore) per illuminazione base

Equipped:

- trolley
- anti-tipping device
- polished stainless steel structure
- remote control, 3 power levels
- sensor LED lighting kit

Dolce Vita - manuale • manual
LF12M2 M0000
LF12M2 L0000

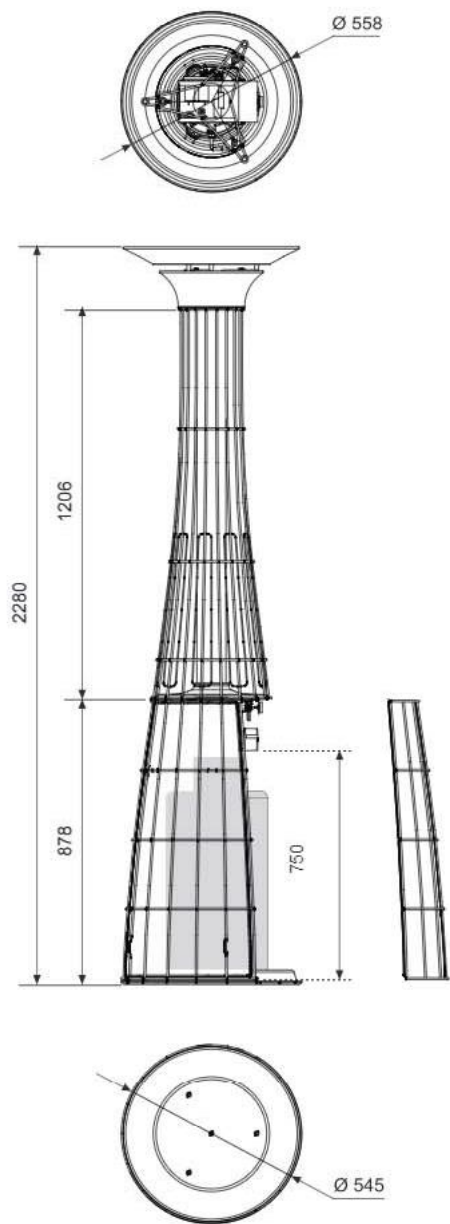

Dolce Vita - infrarossi • remote control
LF12A2 M0000
LF12A2 L0000

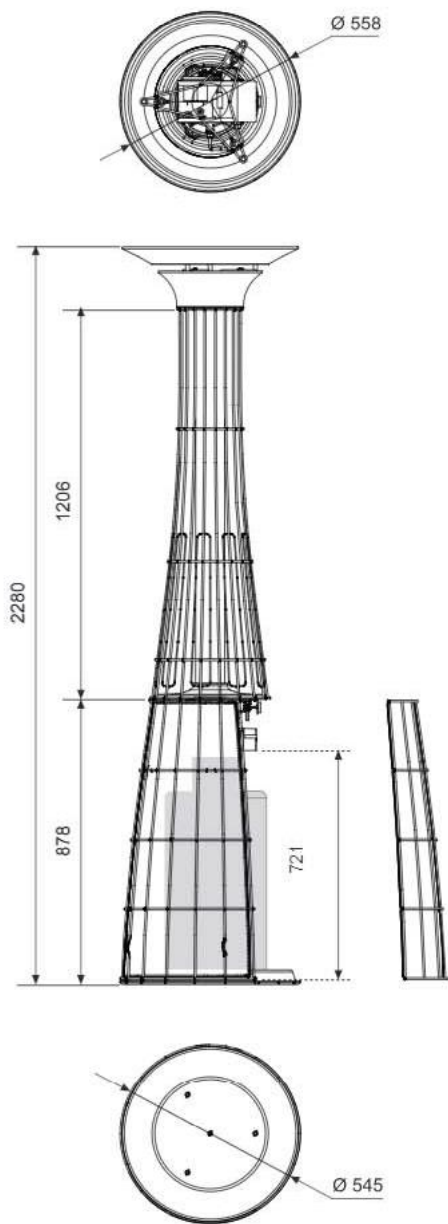

Dolce Vita E.P. - infrarossi • remote control
LF12A2 MG000
LF12A2 LG000

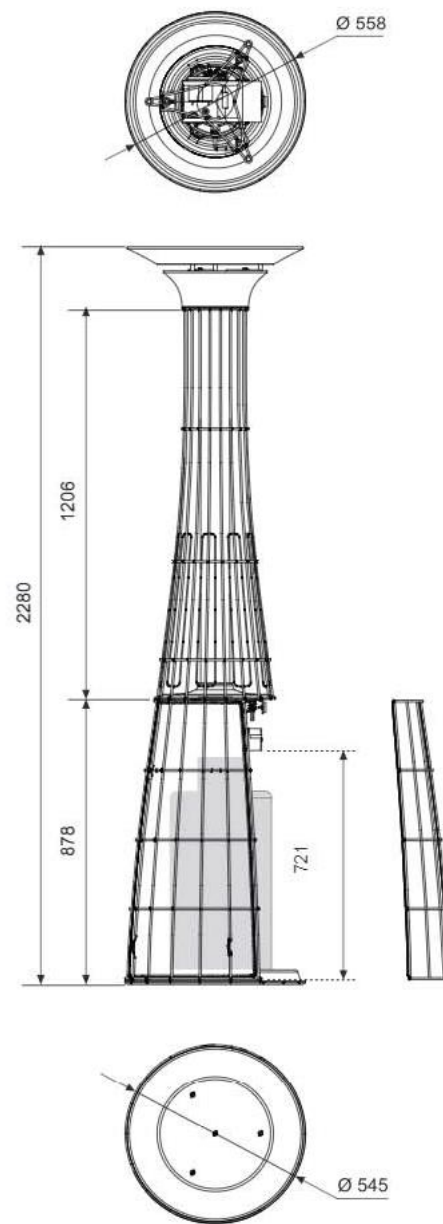

Falò EVO comando MANUALE
Falò EVO MANUAL control

Dotazioni:

- dispositivo di sicurezza antiribaltamento con blocco automatico alimentazione gas
- piedini in gomma antigraffio
- comando manuale, vari livelli di potenza

Equipped:

- anti-tipping device
- rubber feet
- manual control, various power levels



Falò EVO comando INFRAROSSI
Falò EVO REMOTE control



Dotazioni:

- dispositivo di sicurezza antiribaltamento con blocco automatico alimentazione gas
- piedini in gomma antigraffio
- centralina comando con ricevitore, 3 livelli di potenza

Equipped:

- anti-tipping device
- rubber feet
- remote control, 3 power levels



Falò EVO - manuale • manual

-  FL12ME M0100
FL12ME L0100
-  FL12ME M0300
FL12ME L0300
-  FL12ME M0400
FL12ME L0400
-  FL12ME M0200
FL12ME L0200

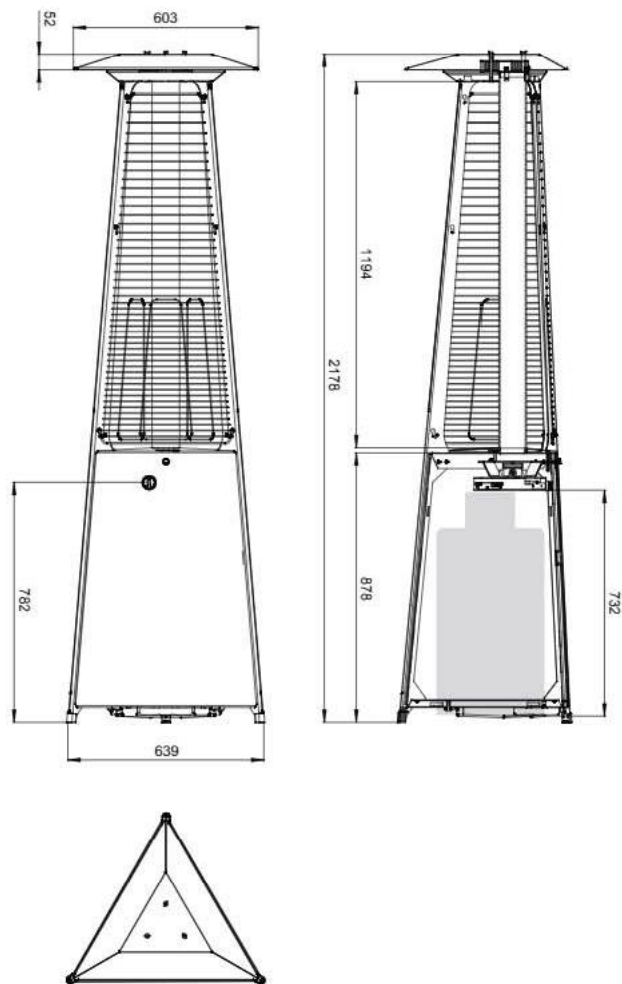

Falò EVO - infrarossi • remote control

-  FL12AE M0100
FL12AE L0100
-  FL12AE M0300
FL12AE L0300
-  FL12AE M0400
FL12AE L0400
-  FL12AE M0200
FL12AE L0200

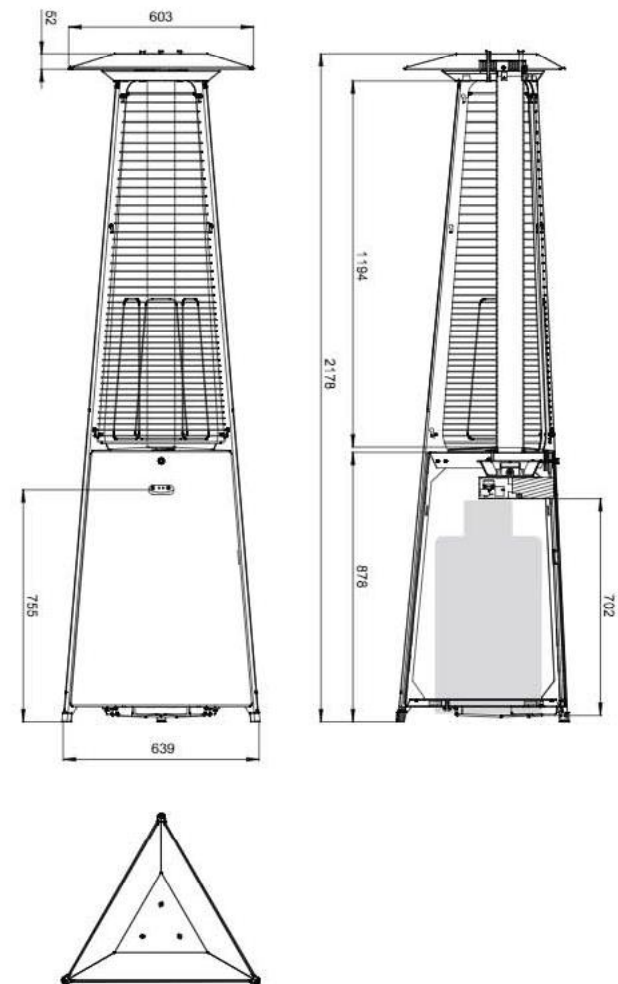

Falò comando MANUALE
Falò MANUAL control

Dotazioni:

- dispositivo di sicurezza antiribaltamento con blocco automatico alimentazione gas
- piedini in gomma antigraffio
- comando manuale, vari livelli di potenza

Equipped:

- anti-tipping device
- rubber feet
- manual control, various power levels



Falò comando INFRAROSSI
Falò REMOTE control



Dotazioni:

- dispositivo di sicurezza antiribaltamento con blocco automatico alimentazione gas
- piedini in gomma antigraffio
- centralina comando con ricevitore, 3 livelli di potenza

Equipped:

- anti-tipping device
- rubber feet
- remote control, 3 power levels



Falò - manuale • manual



FL12M0 M0100
FL12M0 L0100

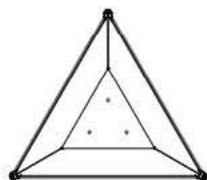

Falò - infrarossi • remote control



FL12A0 M0100
FL12A0 L0100

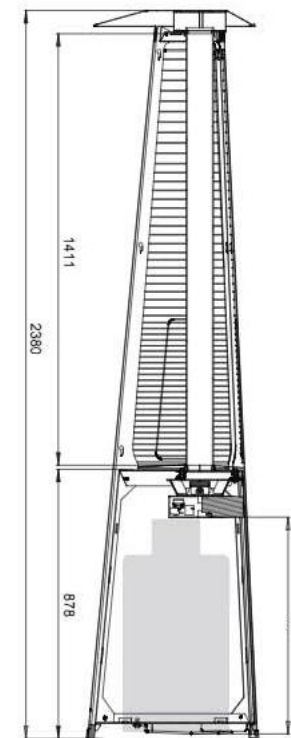
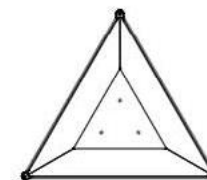
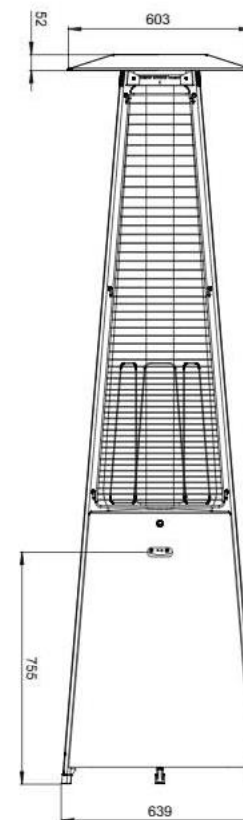

Spider comando INFRAROSSI
Spider REMOTE control



Dotazioni:

- attacco per sospensione (L 16cm)
- centralina comando con ricevitore, vari livelli di potenza

Equipped:

- hook for suspension (L 16cm)
- Remote control model, 3 power levels



Spider - infrarossi • remote control

RE07AS M0000

RE07AS L0000

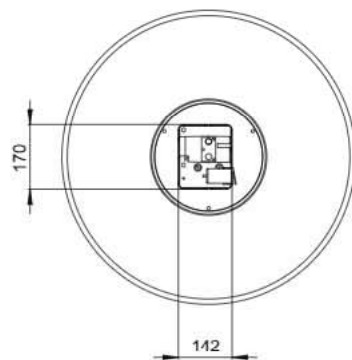
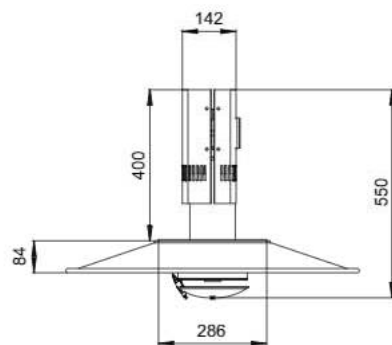
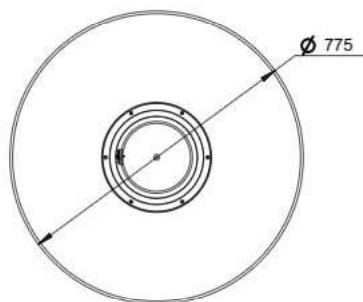

Torcia comando INFRAROSSI - INCASSO
Torcia REMOTE control - BUILT IN



Dotazioni:

- telecomando base a raggi infrarossi (senza display)
- centralina comando con ricevitore, 3 livelli di potenza
- cilindro in vetro trasparente

Equipped:

- standard infrared remote control (with no display)
- remote control model, 3 power levels
- cylinder in transparent glass



Torcia - infrarossi • remote control

TN09A0 M1000

TN09A0 L1000

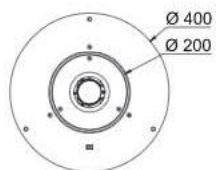
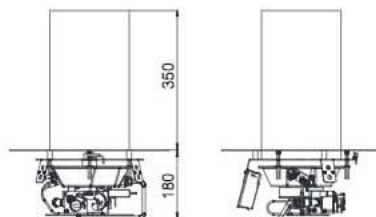

Torcia comando INFRAROSSI - IN RILIEVO
Torcia REMOTE control - FREESTANDING



Dotazioni:

- telecomando base a raggi infrarossi (senza display)
- centralina comando con ricevitore, 3 livelli di potenza
- cilindro in vetro trasparente
- copertura esterna bruciatore

Equipped:

- standard infrared remote control (with no display)
- remote control model, 3 power levels
- cylinder in transparent glass
- cover external burner



Torcia - infrarossi • remote control

TN09A0 M0000

TN09A0 L0000

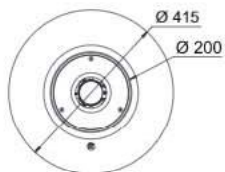
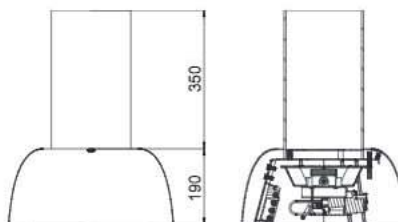



Italkero

S T I L
N O V O



Italkero

INDUSTRIAL

Italkero s.r.l. Via Lumumba, 2 - 41122 Modena | T. +39 059 2550711 | F. +39 059 4900500 | info@italkero.it | www.italkero.it | www.italkero.com

NOTA: In caso di modifiche sostanziali del prodotto, le caratteristiche estetiche e dimensionali, i dati tecnici, gli equipaggiamenti e gli accessori possono essere soggetti a variazione.
NOTE: In case of major product upgrading, aesthetic and dimensional features, technical details, fittings and accessories could undergo changes and are not binding.